

Article number: 12348000060110  
Description: KLEE-coil 348 000 060.110  
M 6 Hardened/zinc-plated Blue

## Measures

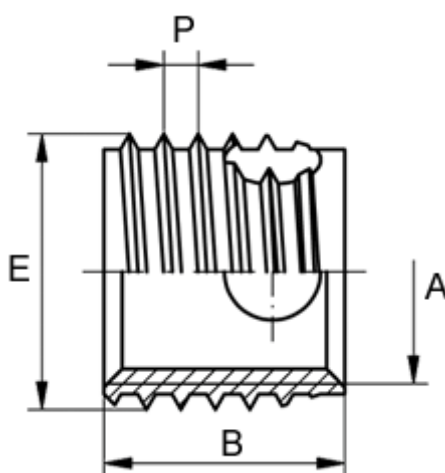

Female thread A	= M6
Length B	= 12
Male thread E	= 8.0
Min hole depth blind hole	= 15
Pre-drilled max	= 7.7
Pre-drilled min	= 7.5
Thread pitch P	= 1.00
Type	= 348 000 060 ...